

ACiQ

PTAC

SERIES



Wall
Sleeve

INSTALLATION MANUAL

WALL SLEEVE INSTALLATION INSTRUCTIONS

SLEEVE HARDWARE

ITEM	DESCRIPTION	QT'Y	REMARK
1	BOTTOM COVER	1	
2	TOP COVER	1	
3	LEFT COVER	1	
4	RIGHT COVER	1	
5	LONG/SHORT SCREW	4/14	

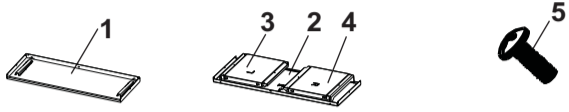

INSTALL THE SLEEVE

- Open the LEFT COVER and RIGHT COVER as shown below. (See Fig.1)

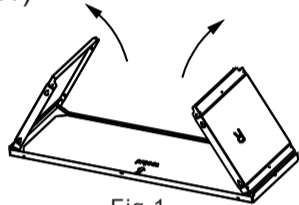

Fig.1

- Install 6 short screws as shown below. (See Fig.2)

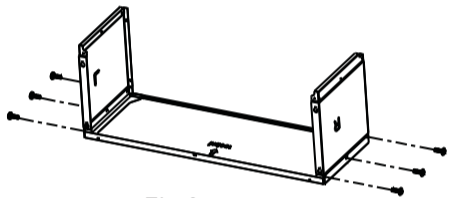

Fig.2

①

INSTALL THE SLEEVE (CONTINUED)

- Install the BOTTOM COVER with the LEFT COVER and RIGHT COVER together by using 8 short screws as shown below. (See Fig.3)

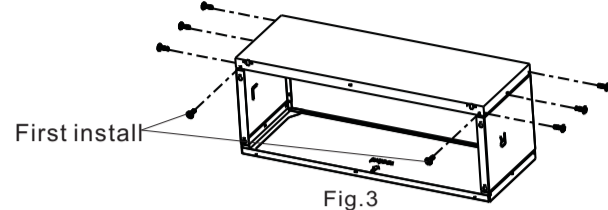

Fig.3

- Turn the SLEEVE as shown below. (See Fig.4)

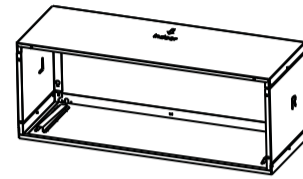

Fig.4

UNIT INSTALLATION

NOTE: Below 2 steps only for referenc, detail steps please refer to actual unit.

- Lift unit level and slide unit into wall sleeve until firmly against front of wall sleeve and secure with 4 long screws through the unit flange holes. (See Fig.5 and Fig.6)

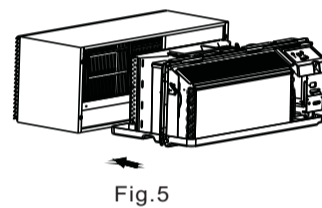

Fig.5

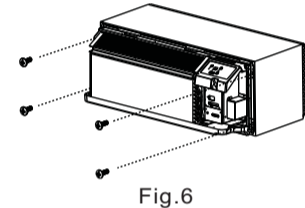

Fig.6

②

DRAIN KIT (OPTIONAL) INSTALLATION INSTRUCTIONS

DRAIN KIT PARTS LIST

ITEM	DESCRIPTION	QT'Y	REMARK
1	COVER PLATE WITH DRAIN OUTLET	1	
2	FOAM GASKET WITH DRAIN OUTLET	6	
3	COVER PLATE(optional)	2	
4	BENT TUBE(optional)	1	
5	STRAIGHT TUBE(optional)	1	
6	SCREW ST3.9*14(optional)	6	

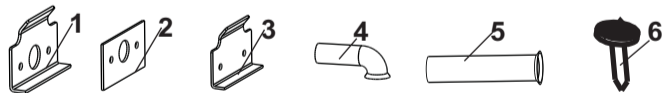

HOW TO INSTALL THE DRAIN KIT

You can choose outside drainage or inside drainage. See the following procedures to perform outside drainage.

- Attach foam gasket to cover plate as shown below.

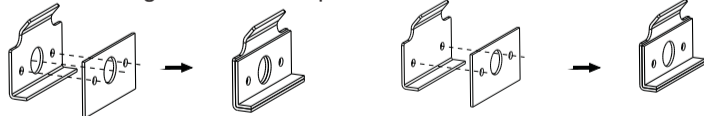

- Insert the bent tube into the cover plate with drain outlet as shown below.



- Rotate the tube to the proper position as shown below.

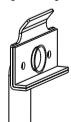

③

HOW TO INSTALL THE DRAIN KIT (CONTINUED)

- Install the cover plate with tube to the drain outlet located at the back of the sleeve by using two screws and install the cover plate without tube to the other drain outlet by using two screws as shown below.

NOTE: The cover plate with tube may be placed on either side of the sleeve. Before tightening the screws, make sure the tube's position will allow the sleeve to fit through the wall.

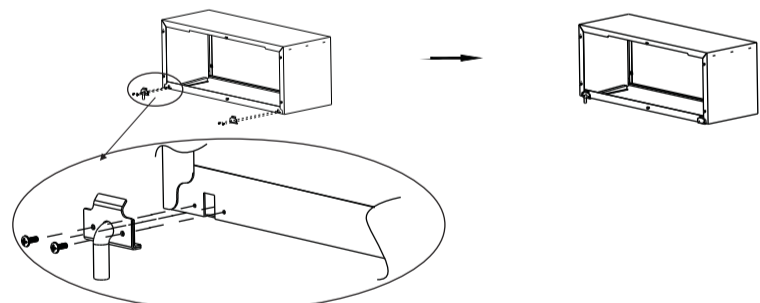

See the following procedures to perform inside drainage.

- Attach foam gasket to cover plate as shown below.

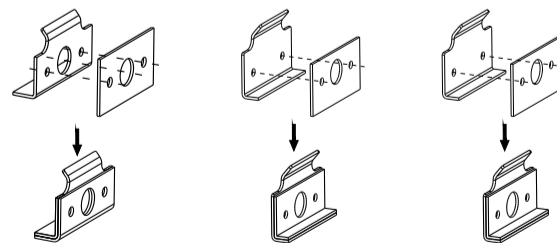

- Insert the straight tube into the cover plate with drain outlet as shown below.

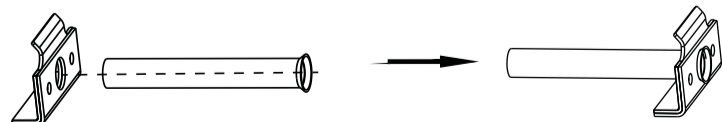

④

HOW TO INSTALL THE DRAIN KIT (CONTINUED)

- Drill two 1/8-inch holes in suitable position of the bottom of the wall sleeve to line up with the holes of the cover plate as shown below. Then drill one 0.4"~0.5" hole in the middle of the above two holes as shown below.

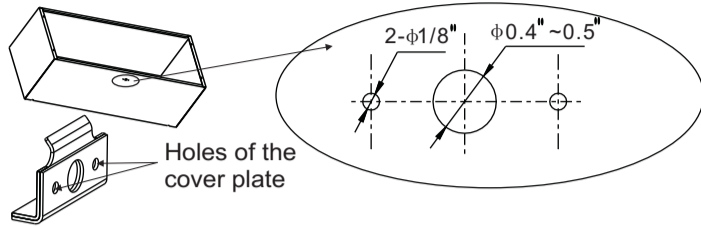

- First install the cover plate with tube to the bottom of the wall sleeve by using two screws with light strength as shown below, then fasten tightly two screws at the same time with not more strong strength to avoid to injure the tube.

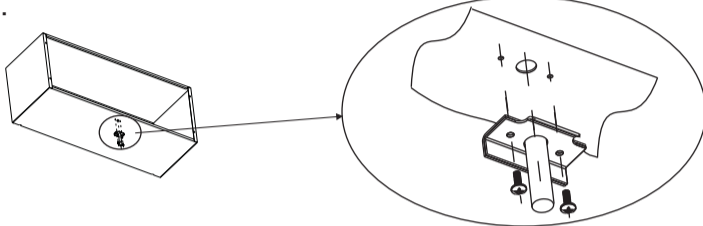

- Install the other two cover plates to the drain outlet located at the back of the wall sleeve by using four screws as shown below, fasten tightly and do not make water leak.

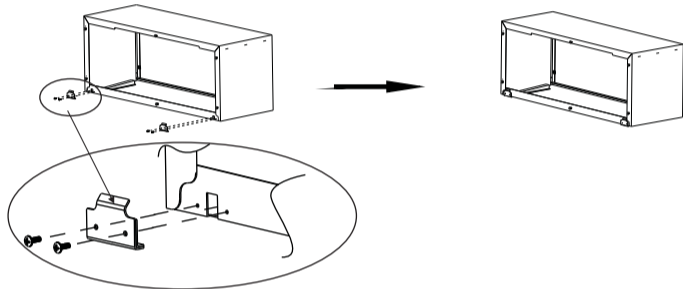

⑤

HOW TO INSTALL THE DRAIN KIT (CONTINUED)

NOTE: When you choose the inside drainage, make sure the water be leaded to the floor drain or a suitable drainage facility with a water hose (local purchase) to the straight tube to avoid water to flow to the indoor floor. The drainage facility should be lower than the drain outlet of the wall sleeve.

NOTE: When you choose the outside drainage, must install a cover plate without hole to the drain outlet of the bottom of the wall sleeve by using two screws and make sure water do not leak as shown below. Make sure the plate's position will allow the sleeve to fit through the wall.

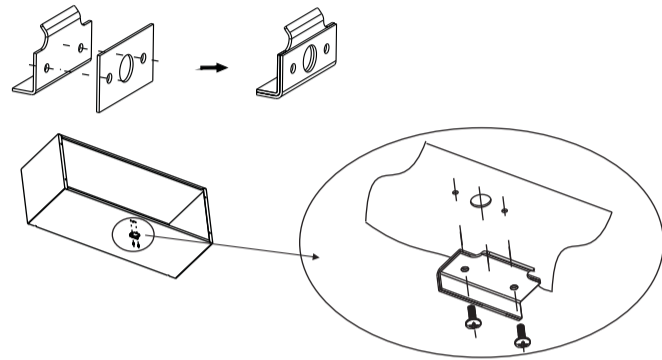

⑥ CW054I-PTAC(ZDQT) 2020001B5381